

CAUTIONS

KNIVES



GAMILLUS *Today*



Stiletto manufactured by
Camillus for the U. S.
Marine Corps Rangers
during World War II.



*Camillus
has the edge!*

POCKET KNIVES

MANUFACTURED BY
CAMILLUS CUTLERY COMPANY
60 East 42nd Street • New York 17, N. Y.
FACTORY—CAMILLUS, N. Y.—NEAR SYRACUSE

THE PARTS OF A

POCKET KNIFE

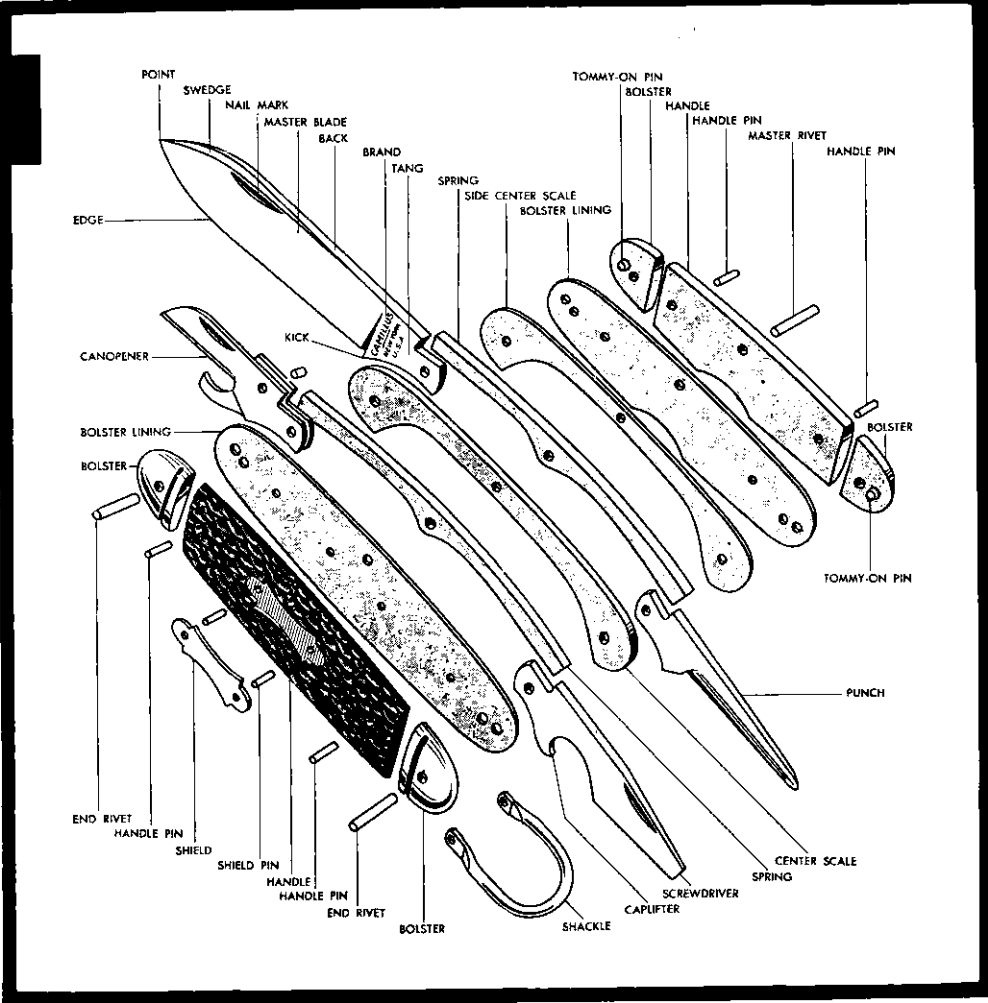

KNIFE BLADES

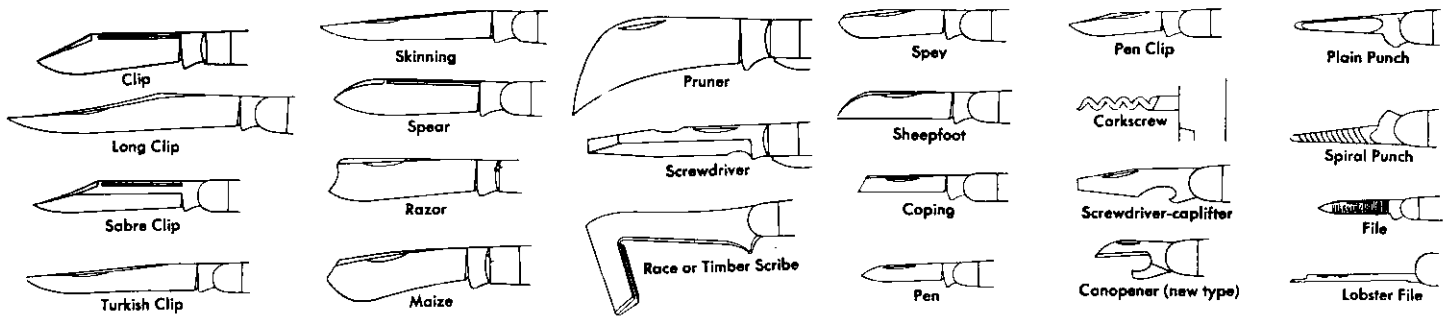

KNIFE PATTERNS

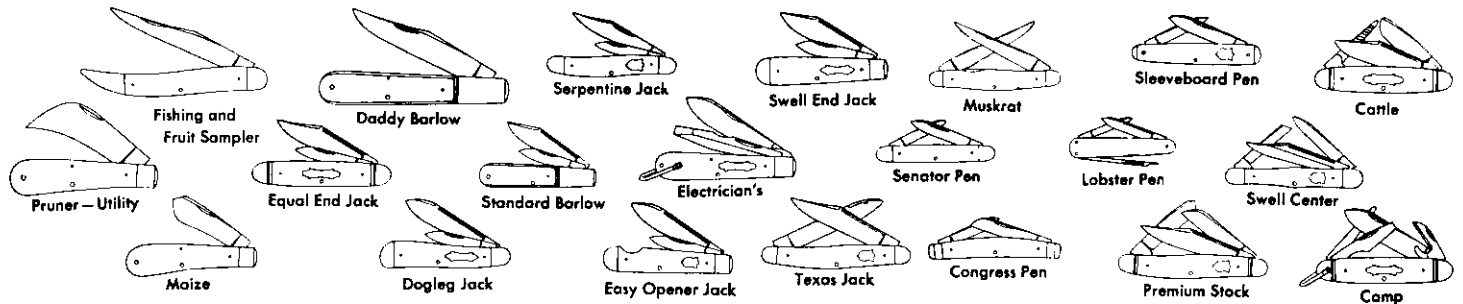

CAMILLUS

has the edge!

Why CAMILLUS HAS THE EDGE

- **BLADES** - of custom-made high carbon cutlery steel providing extra sharpness, toughness and durability - edges hand honed under oil to provide keenest cutting edge possible.
- **CONSTRUCTION** - Precision made to exacting tolerances. Solid handles of the most durable and attractive stag and plastic.
- **APPEARANCE** - high polish, matched handles. most popular patterns supply customer attraction.
- **PACKAGING** - Each knife wrapped in cellophane for more eye appeal, less handling, more protection. New smart boxes numbered on the bottom section to avoid mix-ups.
- **ADVERTISING AND SALES PROMOTION** - the line is supported by national consumer advertising. Display cases, knife stands, counter cards and streamers tie into the program.
- **CAMILLUS CUTLERY COMPANY** is one of the oldest and largest in the country - over 72 years of pocket knife experience - the country's most modern pocket knife factory.

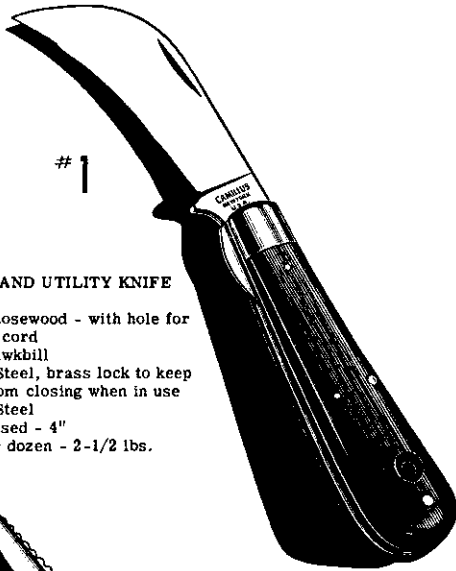

PRUNING AND UTILITY KNIFE

Handle - Rosewood - with hole for cord
 Blade - Hawkbill
 Linings - Steel, brass lock to keep blade from closing when in use
 Bolster - Steel
 Length Closed - 4"
 Weight per dozen - 2-1/2 lbs.

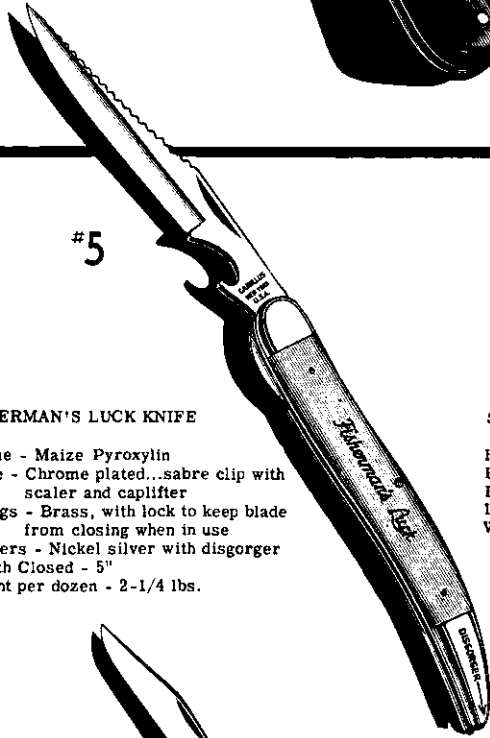

FISHERMAN'S LUCK KNIFE

Handle - Maize Pyroxylin
 Blade - Chrome plated...sabre clip with scaler and caplifter
 Linings - Brass, with lock to keep blade from closing when in use
 Bolsters - Nickel silver with disgorger
 Length Closed - 5"
 Weight per dozen - 2-1/4 lbs.

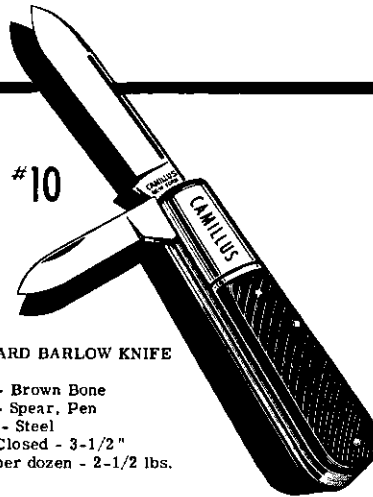

STANDARD BARLOW KNIFE

Handle - Brown Bone
 Blades - Spear, Pen
 Bolster - Steel
 Length Closed - 3-1/2"
 Weight per dozen - 2-1/2 lbs.

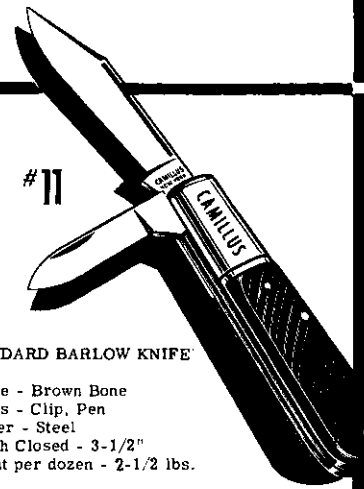

STANDARD BARLOW KNIFE

Handle - Brown Bone
 Blades - Clip, Pen
 Bolster - Steel
 Length Closed - 3-1/2"
 Weight per dozen - 2-1/2 lbs.



SERPENTINE JACK KNIFE

Handle - Stagged
 Blades - Clip, Pen
 Length Closed - 3-3/8"
 Weight per dozen - 1-1/2 lbs.



SERPENTINE JACK KNIFE

Handle - Red Horn Pyroxylin
 Blades - Clip, Pen
 Length Closed - 3-3/8"
 Weight per dozen - 1-1/2 lbs.

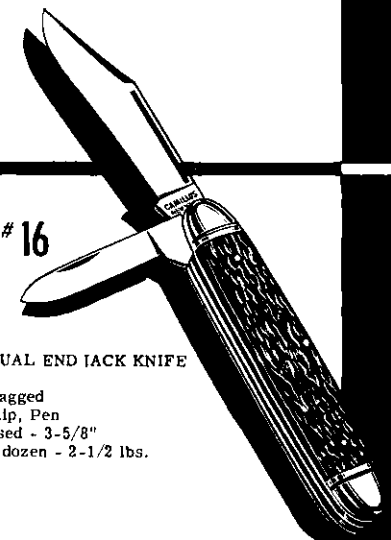

HEAVY EQUAL END JACK KNIFE

Handle - Stagged
 Blades - Clip, Pen
 Length Closed - 3-5/8"
 Weight per dozen - 2-1/2 lbs.

CAMILLUS POCKET KNIVES

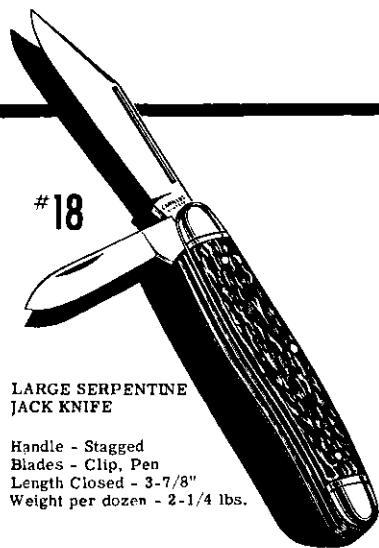

#18

LARGE SERPENTINE JACK KNIFE

Handle - Stagged
Blades - Clip, Pen
Length Closed - 3-7/8"
Weight per dozen - 2-1/4 lbs.



#20

SPORTSMAN'S KNIFE
(Skinning, Hunting, Trapping)

Handle - Stagged
Blades - 2 Skinning Clip
Length Closed - 3-7/8"
Weight per dozen - 1-3/4 lbs.



#21

PONY JACK KNIFE

Handle - Stagged
Blades - Sabre Clip, Pen
Length Closed - 2-13/16"
Weight per dozen - 1-1/4 lbs.

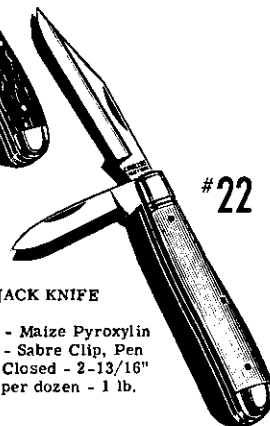

#22

PONY JACK KNIFE

Handle - Maize Pyroxylin
Blades - Sabre Clip, Pen
Length Closed - 2-13/16"
Weight per dozen - 1 lb.

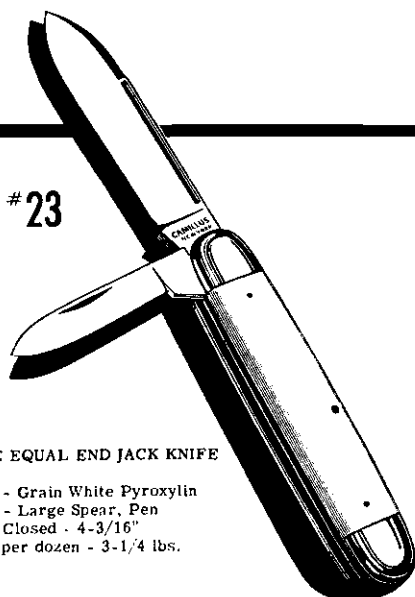

#23

LARGE EQUAL END JACK KNIFE

Handle - Grain White Pyroxylin
Blades - Large Spear, Pen
Length Closed - 4-3/16"
Weight per dozen - 3-1/4 lbs.

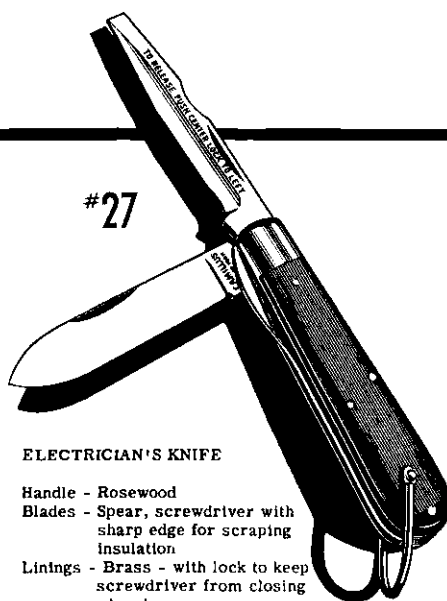

#27

ELECTRICIAN'S KNIFE

Handle - Rosewood
Blades - Spear, screwdriver with sharp edge for scraping insulation
Linings - Brass - with lock to keep screwdriver from closing when in use
Shackle - Nickel Silver
Length Closed - 3-3/4"
Weight per dozen - 3 lbs.



#33

EASY-OPENER JACK KNIFE

Handle - Stagged
Blades - Spear, Pen
Length Closed - 3-3/8"
Weight per dozen - 2 lbs.

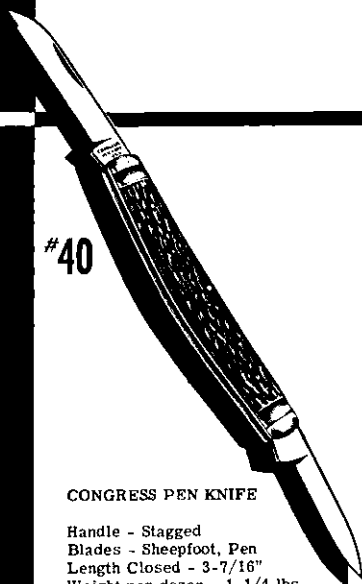

#40

CONGRESS PEN KNIFE

Handle - Stagged
Blades - Sheepfoot, Pen
Length Closed - 3-7/16"
Weight per dozen - 1-1/4 lbs.

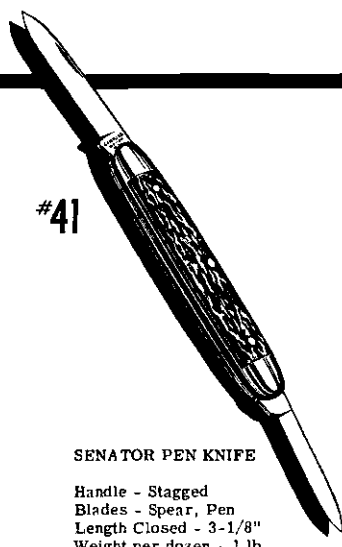

#41

SENATOR PEN KNIFE

Handle - Stagged
Blades - Spear, Pen
Length Closed - 3-1/8"
Weight per dozen - 1 lb.

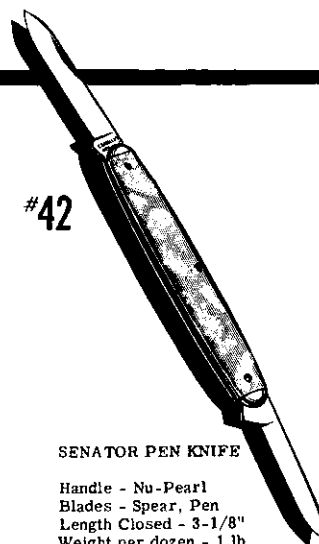

#42

SENATOR PEN KNIFE

Handle - Nu-Pearl
Blades - Spear, Pen
Length Closed - 3-1/8"
Weight per dozen - 1 lb.



#43

SLIM SENATOR PEN KNIFE

Handle - Nu-Pearl
Blades - Spear, File
Shackle - Nickel Silver
Length Closed - 2-13/16"
Weight per dozen - 3/4 lb.

● GENERAL DESCRIPTION OF KNIVES Linings - brass except where specified. Bolsters, Tips - Nickel silver except where specified. Packed - 1/2 dozen in a box. Illustration Size - 1/2 actual size.

CAMILLUS POCKET KNIVES

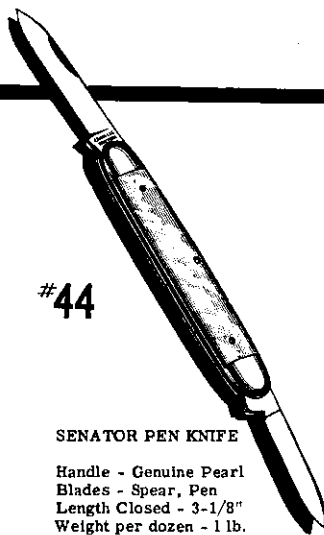

#44

SENATOR PEN KNIFE

Handle - Genuine Pearl
Blades - Spear, Pen
Length Closed - 3-1/8"
Weight per dozen - 1 lb.

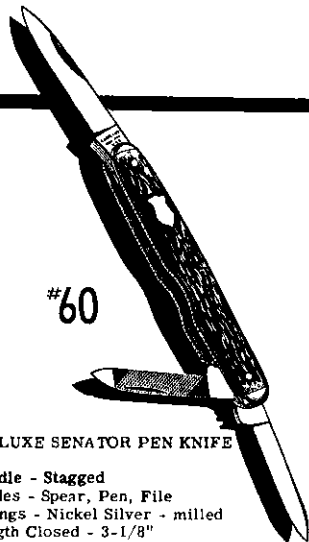

#60

DE LUXE SENATOR PEN KNIFE

Handle - Stagged
Blades - Spear, Pen, File
Linings - Nickel Silver - milled
Length Closed - 3-1/8"
Weight per dozen - 1-1/4 lbs.



#61

DE LUXE SENATOR PEN KNIFE

Handle - Genuine Pearl
Blades - Spear, Pen, File
Linings - Nickel Silver - milled
Length Closed - 3-1/8"
Weight per dozen - 1-1/4 lbs.

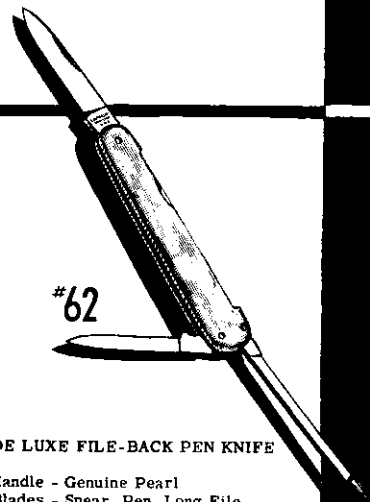

#62

DE LUXE FILE-BACK PEN KNIFE

Handle - Genuine Pearl
Blades - Spear, Pen, Long File
Linings - Nickel Silver - milled
Length Closed - 2-3/4"
Weight per dozen - 1 lb.

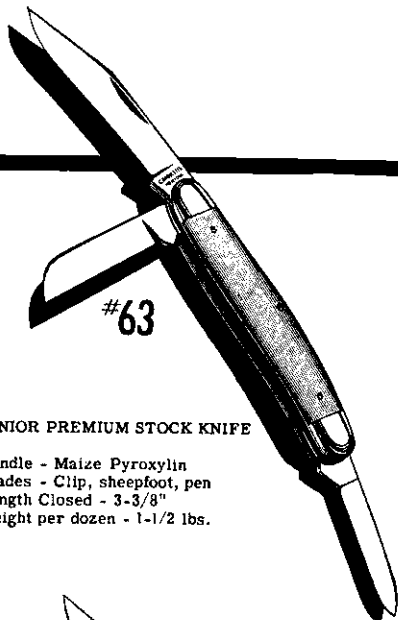

#63

JUNIOR PREMIUM STOCK KNIFE

Handle - Maize Pyroxylin
Blades - Clip, sheepfoot, pen
Length Closed - 3-3/8"
Weight per dozen - 1-1/2 lbs.

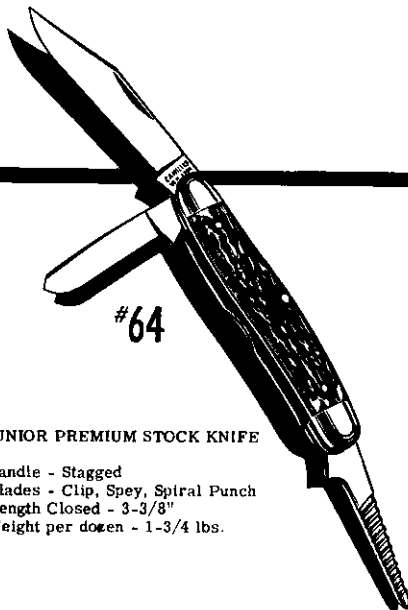

#64

JUNIOR PREMIUM STOCK KNIFE

Handle - Stagged
Blades - Clip, Spey, Spiral Punch
Length Closed - 3-3/8"
Weight per dozen - 1-3/4 lbs.



#65

JUNIOR PREMIUM STOCK KNIFE

Handle - Brown Horn Pyroxylin
Blades - Clip, Sheepfoot, Spey
Length Closed - 3-3/8"
Weight per dozen - 1-1/2 lbs.

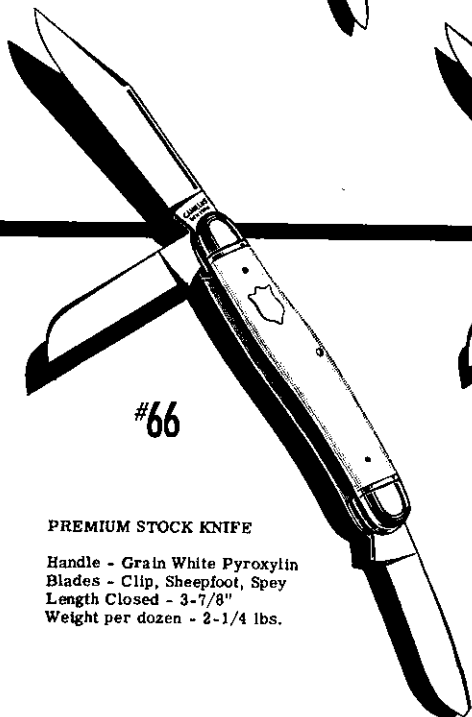

#66

PREMIUM STOCK KNIFE

Handle - Grain White Pyroxylin
Blades - Clip, Sheepfoot, Spey
Length Closed - 3-7/8"
Weight per dozen - 2-1/4 lbs.

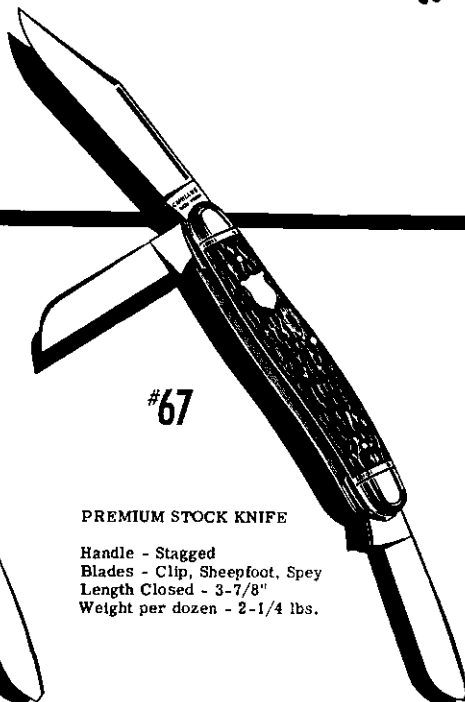

#67

PREMIUM STOCK KNIFE

Handle - Stagged
Blades - Clip, Sheepfoot, Spey
Length Closed - 3-7/8"
Weight per dozen - 2-1/4 lbs.



#68

PREMIUM STOCK KNIFE

Handle - Stagged
Blades - Clip, Spey, Spiral Punch
Length Closed - 3-7/8"
Weight per dozen - 2-1/4 lbs.

● GENERAL DESCRIPTION OF KNIVES - Linings - brass except where specified. Bolsters, Tips - Nickel silver except where specified. Packed - 1/2 dozen in a box. Illustration Size - 1/2 actual size.

CAMILLUS POCKET KNIVES



#69

DE LUXE PREMIUM STOCK KNIFE

Handle - Bone Stag
Blades - Turkish Clip, Sheepfoot, Spey
Linings - Nickel Silver, Milled
Length Closed - 4"
Weight per dozen - 2-1/4 lbs.

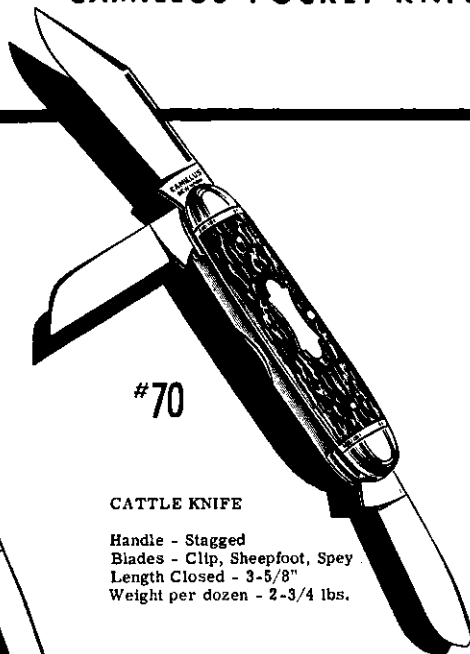

#70

CATTLE KNIFE

Handle - Stagged
Blades - Clip, Sheepfoot, Spey
Length Closed - 3-5/8"
Weight per dozen - 2-3/4 lbs.

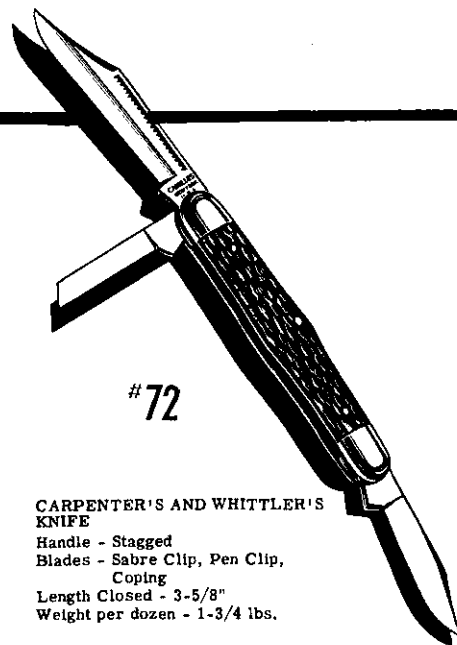

#72

CARPENTER'S AND WHITTLER'S KNIFE

Handle - Stagged
Blades - Sabre Clip, Pen Clip, Coping
Length Closed - 3-5/8"
Weight per dozen - 1-3/4 lbs.

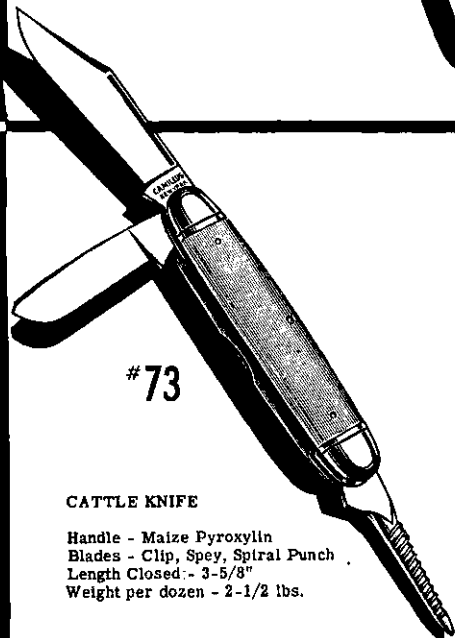

#73

CATTLE KNIFE

Handle - Maize Pyroxylin
Blades - Clip, Spey, Spiral Punch
Length Closed - 3-5/8"
Weight per dozen - 2-1/2 lbs.



#91

CONGRESS KNIFE

Handle - Stagged
Blades - 2 Sheepfoot, 2 Pen
Length Closed - 3-7/16"
Weight per dozen - 1-3/4 lbs.



#99

CAMP KNIFE

Handle - Stagged
Blades - Spear, Canopener, Punch, Screwdriver-cuplifter
Shackle - Nickel Silver
Length Closed - 3-5/8"
Weight per dozen - 3 lbs.

● GENERAL DESCRIPTION OF KNIVES - Linings - brass except where specified. Bolsters, Tips - Nickel silver except where specified. Packed - 1/2 dozen in a box. Illustration size - 1/2 actual size.

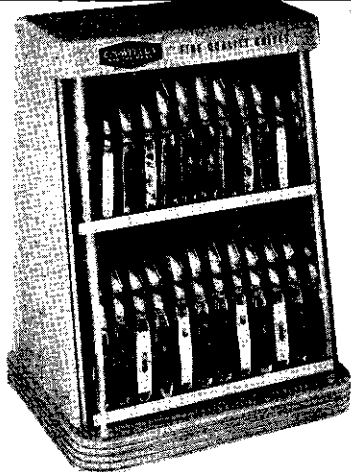

#46-24L DISPLAY CASE

Handsome, bleached oak, bright red knife panel, curved Lucite



front. Modern and attractive. Displays 24 knives. White strips for numbers and prices. Large storage space holds 24 dozen knives. Door locks.

Size: 18-3/4" high x 13-3/4" wide x 10" deep (at base). Each securely packed in corrugated container. Weight: 18 lbs. each.



#131 SHARPENING UNIT

For sharpening, oiling and cleaning customers' knives. Makes yours a real cutlery department. Brings out his knife for the sale of a new "Camillus" knife.

Base size: 8-3/4" x 5-3/4" x 3/4". Contains 6" x 2" Carborundum stone, 3-in-One can of oil, Velveteen wiping cloth. Card gives correct sharpening instructions. Each securely packed in corrugated container. Weight: 1-3/4 lbs. each.

1.

PRECISION PRODUCTION

At Camillus precision production is assured by the combination of superior materials . . . modern, high-speed manufacture . . . highly skilled hand craftsmanship . . . and over 72 years of experience. Top quality in every knife is made certain by an exacting "quality control" inspection system. Thus Camillus produces the fine quality that satisfies customers—at the low prices that complete sales.

2.

PROMOTION

National Consumer Advertising—in leading magazines such as "Saturday Evening Post", "Life", "Country Gentleman" and "Field and Stream" sets up the consumer demand that starts sales for you.

Point-of-Sale—displays, streamers and cards tie into this advertising, create new customers and boost your volume.

Clever Packaging—simplifies handling, eliminates stock mix-ups and cuts stock losses.

3.

PRIDE

You have the confidence that comes from handling the best when you carry the CAMILLUS line. You know that the fine quality built into every knife will make satisfied customers. These satisfied customers give you the best advertising you can get. So it is that you are proud of the sale and proud of the product when you sell CAMILLUS knives.

4.

PROFIT

The real payoff comes when the fine quality, reasonable prices and steady promotion give you faster turnover. Faster turnover means more profit. It means that with Camillus you do a better pocket knife business.

THE CAMILLUS PROGRAM



THE CARE OF A KNIFE

If a knife is properly cared for it will give longer and more satisfactory service. Instruct your customers in the correct care of their knives. They'll appreciate this added service.

Sharpening

This is the only correct method—read it carefully.

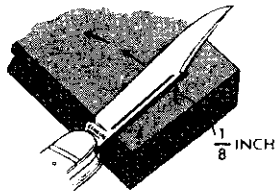

1 Oil the stone so top is fairly moist.

2 Lay blade edge on stone. Raise back of blade about $\frac{1}{8}$ " above stone.

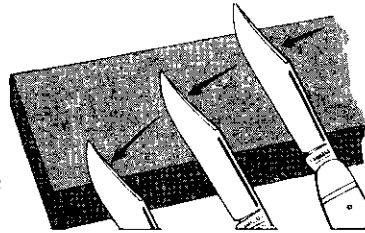

3 Sharpen against the edge (as if cutting into the stone)... drawing the blade toward you off the stone at the same time.

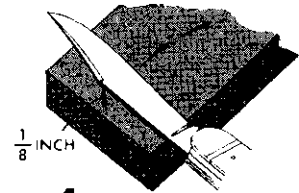

4 On alternate strokes sharpen other side of edge by reversing this operation.

Clean the stone after use.

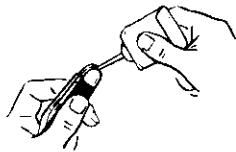

Oiling

The joints of a knife need oil just like a machine. Clean out the dirt, then put a drop of light oil at each joint. Work the oil in by moving the blade back and forth.

Wiping

To prevent stain or rust, wipe knives clean after contact with moisture or perspiration. Polish the brass and nickel silver with a little silver polish.



THE CARE OF SAMPLES

Uniform arrangement of well-made, well-kept pocket knives starts sales on the way. Here's how to keep your knives and display in tip-top condition.



1. Keep a wiping cloth and a small can of oil with your display.

2. See that all knives are wiped clean after each handling.

3. Every month or two clean off display case window, panel and knives. At the same time rub up the nickel silver and brass of display samples to a bright, shiny finish.

4. Your clerks should all know how to properly sharpen a knife, as per instructions on the back of display case and above.

MR. DEALER

HOW YOU CAN SELL MORE POCKET KNIVES

1. KEEP AN ADEQUATE STOCK

Stock all salable patterns (larger quantities of the fast sellers). When a customer wants a certain knife—you have it.

2. KEEP SAMPLES CLEAN

Bright and shiny display samples help to sell knives. Make your knives look worth your selling price.

3. DISPLAY IN GOOD, LIGHTED POSITION

Catch extra "impulse sales" by placing the display in a "Traffic" position. The wrapping counter or near cash register is a good spot.

4. USE PROMOTION MATERIAL

This starts sales and ties into Camillus National Consumer Advertising. It's a good reminder to customers who miss seeing your knife display.

5. DISPLAY IN WINDOW

Every little while a mass window display of knives will help establish your store as cutlery headquarters. A card or a few knives on stands should be in every possible window display. Tie into other feature windows—pruning knife with gardening; camp knife and fishing knife with outdoor, hunting or fishing window; gift knives at Christmas.

6. NEWSPAPER ADS

Work Camillus Knives into your regular newspaper ads. This reminder advertising pays off.

7. TIE POCKET KNIVES INTO OTHER SALES THAT ARE RELATED

- #1 Pruning knife to garden equipment.
- #72 Whittler knife to shop and tools.
- #99 Camp knife to outdoor supplies.
- #5 Fisherman's knife to fishing equipment.
- #20 Skinning knife to hunting and trapper equipment and so forth.

8. KNOW ESSENTIAL SALES FACTS

The bottom of each box outlines them for you. Look at them—and have your clerks look at them in their spare time and when making a sale. Pass this catalog to all sales personnel to study.



CAMILLUS
has the edge!